



EVOKING TRUST



**Multi Layered Deep Learning
Analytics at Edge
IP-50 Camera Series**



STARVIS 5MP IR Bullet Ai IP CAMERA

IP-50303LBO-V650



About the Camera : IP 50 Series cameras are Artificial Intelligence powered latest camera series by Wavesys. It is built on advanced system-on-chip technology from California based company Ambarella and Sony Starvis Sensors. The IP50 series cameras are integrated with Wavesys Open Platform Enterprise Level Video Management Software WVMS. Wavesys is a video-based business intelligence leader with deep knowledge of different applications of intelligent video across distinct verticals.

Key Features

- . 30fps at 5MP
- . WaveStream: Smart Compression Technology based on bit rate Control, ROI
- . Power over Ethernet (IEEE 802.3af)
- . UL, CE, FCC, BIS & RoHS Certification
- . H.265, H.264 and MJPEG compression
- . WaveVCA*: Intelligence built-in Camera Analytics
- . IP67 and IK10 Environmental Housing
- . P Iris with Motorized Remote Zoom and Focus
- . Deep Learning Object Tracker/People Tracker

Application





Key features of WVMS

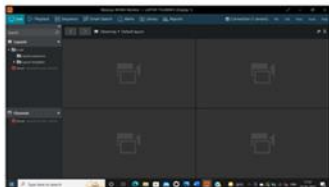

WVMS Professional – Monitoring Console



WVMS Enterprise – Wall & Redundancy



WVMS Facial Recognition Module



WVMS Video Content Analytics



WVMS License Plate Recognition



WVMS Mobile Application

Specification

CAMERA

Model	IP-50303LBO-V650
Image Sensor	SONY STARVIS EXMOR 1/2.8" 5.14M CMOS
Effective Pixels	2592(H) x 1944(V)
Scanning System	Progressive scanning
AGC Control	Auto
IRIS Type	P-IRIS
Minimum Illumination	Color: 0.08 Lux / B/W : 0 Lux (IR LED On)
Lens	6mm-60 mm, F1.6
Angle of View	Horizontal: Approx. 85°, Vertical: Approx. 62°
Shutter Time	Auto / Manual: 1/30 ~ 1/32,000, Anti-Flicker, Slow Shutter (1/2, 1/3, 1/5, 1/6, 1/7.5, 1/10)
Day & Night	True Day & Night (Removable IR-cut filter)
Wide Dynamic Range	True WDR, 120dB or above
Smart Capture Technology	WaveCapture: Smart Advanced Wide Dynamic Capture for high details in challenging conditions
S/N Ratio	50 dB

IR ILLUMINATOR

Smart IR	WaveIR :- Advanced Smart IR
IR LED	6 x High Power LED
IR Working Distance	40 m., depend upon the object size

VIDEO

Video Compression	H.265, H.264, MJPEG
Profile	H.264 : MP / HP H.265 : MP
Multiple Profile Streaming Performance	2592x1944p30 + 1080p15 with H.264, H265 + MJPEG
Max Resolution	2592 x 1944
Video Bit Rate	100Kbps ~ 10Mbps Multi-rate for Preview and Recording
Bitrate Control	Multi Streaming CBR/VBR (Controllable frame rate and Bandwidth)
Digital Noise Reduction	3D-DNR
Privacy Mask	16 programmable zones
Special Features	WaveStream: Smart Compression Technology based on bit rate Control- Region of Interest
Other Image Processing	Configurable Exposure, White Balance, Sharpness
Image Orientation	Flip / Mirror / Corridor Mode
Analogue Output	1 (Installation only) CVBS 1.0V p-p (75Ω), 4:3 aspect ratio

AUDIO

Audio Streaming	Two way
Audio Compression	G.711
Audio input / output	1/1

EVENT

Event Trigger	Motion Alarm, Temperature critical, DI
Smart Edge Analytics*	WaveVCA: Intelligence built-in Cameras Analytics*
Pre-Post Recording	Pre: 1~5 sec Post: 1~240 sec
Event Notification	FTP, E-mail, Alarm-out, SD card

NETWORK

Ethernet Standard	10 / 100 / 1000Base-T
IP	IPv4
Protocol	TCP/IP, UDP, AutoIP, RTP(UDP/TCP), RTSP, NTP, HTTP, HTTPS, SSL, DNS, DDNS, DHCP, FTP, SMTP, ICMP, SNMPv1/v2/v3(MIB-2), ONVIF
Security	HTTPS(SSL), IP filtering, 802.1x, Digest Authentication
Plug In	ONVIF Profile S, CGI API

GENERAL

Material	Aluminum Die-casting, White
External I/O Terminals	1 x Alarm In / 1 x Alarm Out
Language on webpage	English
Power Source	DC12V, PoE+(IEEE 802.3at Class 4)
Power Consumption	DC12V Max 13.2W, PoE Max 14.8W
Operating Conditions	Humidity 10 ~ 90% RH (non-condensing) [DC12V / PoE] -40°C ~ 50°C (-40°F ~ 122°F)
Cold Start	Supported
Approvals	FCC, CE, IP67, IK10, UL
NDAA	Compliant
Weight	1.2 kg
Dimensions (D x H)	247.2mm x 96.7mm

EDGE STORAGE

Storage	1x microSD / microSDHC / microSDXC (card not included)
---------	---



WaveVCA : Intelligence built-in Cameras Analytics

Basic features

Analytics Engine WVCA Technology's advanced tracking algorithm with rich library of detection behaviors

Detection Zones and Rules 40 zones (Multi-segment Polygons and Lines) in total, 60 rules in total as standard

Intrusion Detection Detection of the presence an object

Tamper Detection Supported as standard

Detection Behavior Enter, Exit, Appear, Disappear, Stop, Direction, Dwell filter, Abandoned/Removed object filter, Tailgating

Logical Rules Extends standard rules to allow various combinations of the inputs

3D Behavior Perspective Corrected Size and Speed Filters

Object Classification - Configured Max./Min. object sizes and Max./Min. speeds
Counting Line High accuracy people and vehicle counting, 20 counters in total

Meta Data JSON format, Plain XML format

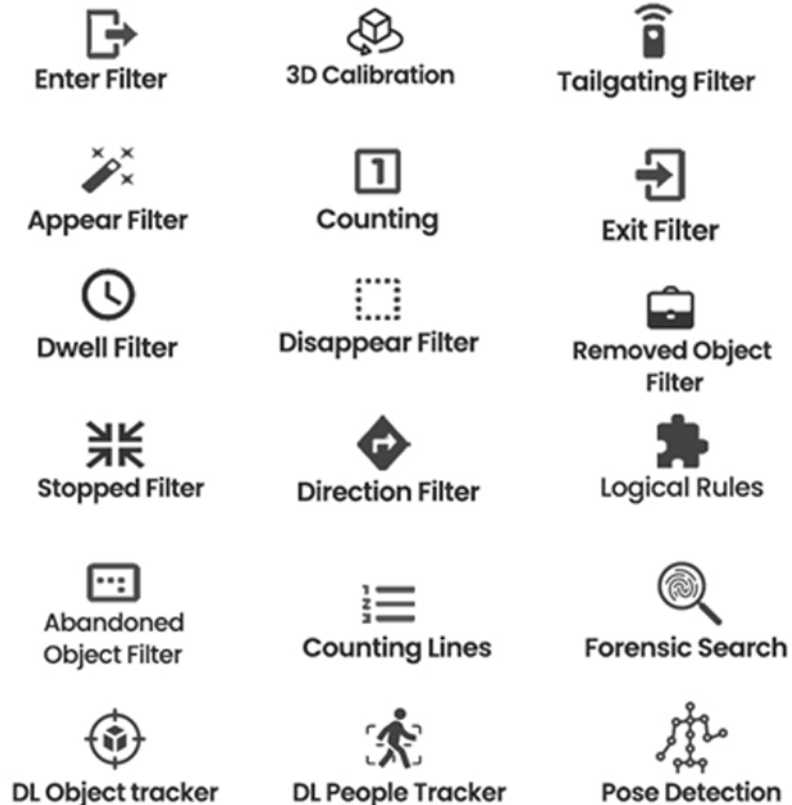

Optional features

Forensic Search Works with age, sentiment, gender, and ethnicity estimation



Dimensions

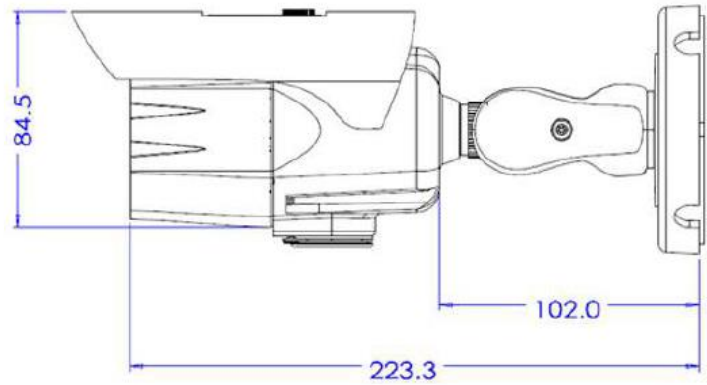
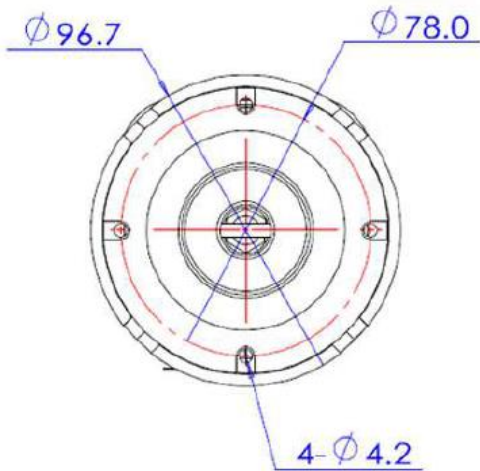

ACCESSORIES



BP07